

# adaptIQ®

## SCHOTT Vials Ready To Use

### Product Specification

Type: adaptIQ® - SCHOTT Vials Ready to Use Tray, material Fiolax® clear - TopLine, Crimp Neck, size 6R NBB

**Manufacturing Site:**

SCHOTT North America Inc., Lebanon Valley Parkway 30, Lebanon, PA 17042, USA

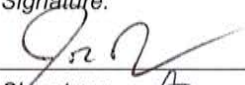
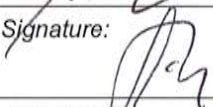
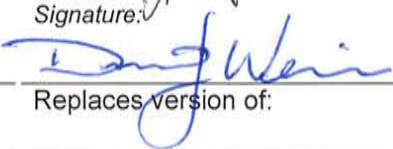
<b>Article-No.</b>	<b>1760349</b>	
<b>Created by:</b> Johnson Dong Technical Customer Support	<b>Signature:</b> 	<b>Date:</b> 04-12-2021
<b>Reviewed by:</b> Andreas Holstein Operations Manager - Sterile	<b>Signature:</b> 	<b>Date:</b> 04-12-2021
<b>Approved by:</b> David Weiser Quality Assurance Manager	<b>Signature:</b> 	<b>Date:</b> 15 APR 2021
<b>Created:</b> 04-12-2021	<b>Replaces version of:</b>	00

<b>Approval of Customer</b>		
<b>Company Stamp:</b>	<b>Signature:</b>	<b>Date:</b>



**Contents**

- 1. Scope ..... 3
- 2. adaptiQ® vial - Product Description..... 3
- 3. adaptiQ® vial - Packaging, Labelling, Storage..... 4
- 4. Product Conformity ..... 5
- 5. Quality Assurance ..... 5
- 6. History ..... 8
- 7. Drawings ..... 8

**CONFIDENTIAL! ONLY FOR DESIGNATED CUSTOMER!**

*\*\*This technical product information shall give the most important technical features of the adaptiQ® vial type mentioned above. Further technical details are always available on request. In any case, only the corresponding specifications released by our quality management are valid.\*\**

## 1. Scope

This documentation applies to adaptiQ® - SCHOTT Vials Ready To Use, TopLine.

adaptiQ® represents a single use, sterile and non-pyrogenic glass vial for packaging parenteral medicinal products specifically designed to deliver reliable performance on our customers filling line.

The filling and closure of the vial is not completed by SCHOTT and is not SCHOTT's responsibility.

## 2. adaptiQ® vial - Product Description

Component	Material Description	Regulatory Reference
<b>Glass vial (TopLine quality)</b>	SCHOTT Fiolax® clear: <ul style="list-style-type: none"> <li>▪ Highly resistant borosilicate tubing glass (Type I) transparent</li> <li>▪ First hydrolytic class according to the current version of EP, USP and JP</li> </ul>	<ul style="list-style-type: none"> <li>▪ Glass Container: USP 660*; EP 3.2.1*; JP 7.01*</li> </ul>
<b>Packaging materials**</b>	<ul style="list-style-type: none"> <li>▪ Tray Base and Tray Lid: Polyethylene Terephthalate Glycol (PETG), Blue</li> <li>▪ Tub Seal: Tyvek® seal</li> <li>▪ Double Bag: Low Density Polyethylene (LDPE)/Polyethylene terephthalate (PET) with Tyvek®</li> <li>▪ Transport box: Akylux®</li> </ul>	<ul style="list-style-type: none"> <li>▪ Polymers according to USP &lt;88&gt; class VI*</li> </ul>
<b>Sterilization</b>	<ul style="list-style-type: none"> <li>▪ ETO Sterilization</li> </ul>	<ul style="list-style-type: none"> <li>▪ ISO 11135*</li> <li>▪ CPMP/QWP/159/01</li> </ul>

\*Current version

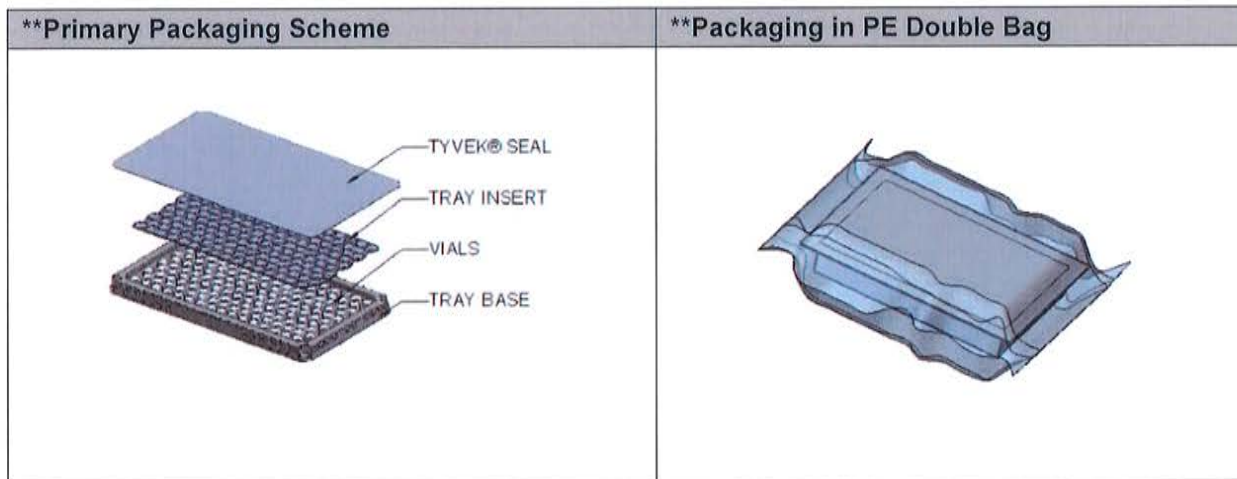

### 3. adaptiQ® vial - Packaging, Labelling, Storage

To protect the vials against contamination and damage, the vials are placed in trays.

The protective Tyvek® seal builds a barrier against microbial contamination (sterile barrier). The LDPE bag acts as a protection against external contamination or damage. Additional plastic layers are put on top and bottom of the box as well as between each layer of trays.

Packaging shall be checked prior to use for the presence of holes, tears, damaged or separated seal, which could affect the product sterility.

Packaging identification may include the following information:

	Tray / PE Bag	Box	Pallet
Supplier Name	x	x	x
Customer Name	-	-	x
Product Description	x	x	x
Article no.	x	x	x
Batch no.	x	x	x
No. of packaging	x	x	x
Quantity	x	x	x
Manufacturing Date	x	x	x
Expiry Date	-	x	-
Type of sterilization	-	-	x
User notices	x	x	-

User notices:

- Non toxic
- Non pyrogenic
- Single use
- Sterile when packaging is closed and undamaged
- User is responsible for compatibility with drug

SCHOTT recommends following good manufacturing practices in packaging, storage and handling of sterile adaptiQ® vials:

- Long term storage (more than 60 days) temperature range is defined within (> 15 °C and < 30°C / > 59°F and <86°F)
- During transport it is allowed to deviate from this requirement
- Storage shall be always above the dew point
- Longer term storage with exposure to sun light is not allowed
- The goods shall be stored in normal warehouse environment (no contaminants in the atmosphere) with pest control in place
- Shelf life is documented per Certificate of Conformity (CoC)
- Minimizing mechanical stress

The adaptiQ® vial is dedicated to be filled with drugs under aseptic conditions. It is the customer's responsibility to use the adaptiQ® vial in a correct way and to verify the stability of the filled drugs.

## 4. Product Conformity

With each batch SCHOTT provides a certificate of conformity (CoC) or a copy CoC in case of partial batch shipments.

The certificate is dated and signed (manually or electronically) by a quality assurance representative.

The adaptiQ® vials and packaging conform to the associated drawings, as released by both parties.

The customer is responsible to validate the vials as appropriate to their own process and use and must make sure that no further manufacturing or transportation steps affect the essential qualities of the vial

## 5. Quality Assurance

The quality system at SCHOTT is defined in the Quality Manual and related procedures. SCHOTT's Quality system is certified under:

- ISO 9001 current version
- ISO 15378 current version

The SCHOTT glass vials made of Type I borosilicate glass fulfil the requirements of the following Pharmacopeia:

- Ph. Eur, chapter 3.2.1
- USP, chapter 660
- JP, chapter 7.01

### General

- Converting line with online dimensional control
- Visual defects checked by Automated Inspection Systems and statistical in-process control
- Packaging in controlled area

### ***Batch Definition / Customer Samples***

A unique 10 digit batch number is used for numbering each batch of the product. The batch number begins with a 6-.

Sampling of SCHOTT adaptiQ® sterile is representative for the total batch produced. Tailgate samples could be supplied on request and are applicable only if a full production batch is delivered. The tailgate samples will be placed in separate box(es) and labelled „Customer Samples“ and the box(es) are included in the palletization configuration of the last pallet.

The sample size is based on a Single Sampling Plan as defined in ISO 2859-1 / ANSI / ASQ Z1.4 Level II.

### ***Quality Level***

SCHOTT is committed to supply a product that meets the following acceptable quality level (AQL) according to ISO 2859-1. / ANSI Z1.4.

For the cosmetic defect inspection level II is taken, for all other inspection, e.g. dimensional defects, inspection level –S4 is used.

Note: If with respect to a certain type of defect the applicable AQL is maintained at the moment of incoming inspection in accordance with the procedures of ISO 2859-1 / ANSI Z1.4, all pieces of the relevant batch shall - with regard to that type of defect - be deemed in compliance with the Specifications.

## AQL Table by category

### Packaging

No.	Defect / Specification	Defect Class.	Defect definition	AQL
I	Product mix-up	C	-	None allowed **
II	Wrong or missing printing or labeling on tray	M (A)	-	0.015
III	Missing tray insert	M (A)	-	None allowed **
IV	Missing vial in tray	M (A)	-	0.1
V	Incomplete seal on tray	M (A)	-	0.065
VI	Incorrectly positioned Tyvek®	M (A)	-	0.1

### Dimensional – Listed defects per dimensions on Product Drawing

No.	Defect/ Specification	Defect Class	Reference dimension only	AQL
10.01.0	Total height (overall length) out of tolerance	M (A)	Reference: Drawing size h1	0.25
10.03.0	Outer body diameter out of tolerance	M (A)	Reference: Drawing size d1	0.25
10.09.0	Neck outer diameter out of tolerance	M (A)	Reference: Drawing size d3	0.25
10.14.0	Flange (collar) outside diameter out of tolerance	M (A)	Reference: Drawing size d2	0.25
10.15.0	Flange (collar) height out of tolerance	M (A)	Reference: Drawing size h21	0.25
10.02.0	Body height out of tolerance	M (A)	Reference: Drawing size h2	0.4
10.05.0	Bottom thickness out of tolerance	M (A)	Reference: Drawing size s2	0.4
10.06.0	Bottom concavity out of tolerance	M (A)	Reference: Drawing size t	0.4
10.10.0	Neck inside diameter out of tolerance	M (A)	Reference: Drawing size d4	0.4
10.12.0	Perpendicularity out of tolerance	M (A)	Reference: Drawing size a	0.4
10.16.0	Lower flange (collar) angle out of tolerance	M (A)	Reference: Drawing size c21	0.4
10.19.0	Neck height out of tolerance	M (A)	Reference: Drawing size h3	0.4
10.04.0	Wall thickness out of tolerance	M (B)	Reference: Drawing size s1	1.0
10.13.0	Flange (collar) angle (top of flange) out of tolerance	N	Reference: Drawing size c22	4.0

## Cosmetic

No.	Defect / Specification	Defect Class.	Defect definition	AQL
04.01.0	Inside contamination	C	Size > 0.3 mm <sup>2</sup> , visible by naked eye	0.1
04.03.0	Outside contamination	N	Not removable, size > 0.5 mm <sup>2</sup>	1.0
04.03.0	Contamination sealing surface (dirt)	M	Visible by naked eye, size > 0.3 mm <sup>2</sup>	0.1
05.18.0	Glass particles inside vial	C	Size > 0.5 mm	None allowed *
05.17.0	Glass particles inside vial	C	Size > 0.2 to 0.5 mm	0.25
05.05.0	Deformed containers, processibility impaired	M (A)	Test according to Visual Inspection of limit samples	0.4
05.06.0	Deformed containers, processibility not impaired	N	Test according to Visual Inspection of limit samples	4.0
05.07.0	Cracks	C	Any size, penetrating the wall	None allowed *
05.10.0	Chips on body	C	Risk of leakage, size > 1 mm	None allowed *
05.08.2	Bump Checks	N	1 check > 0.5 mm or sum of several checks > 1 mm. Not penetrating the wall	1.0
05.09.0	Chips on collar	C	Clearly visible, with risk of leakage > 50% affected in one location of the vial, non-accumulative	None allowed *
05.09.0	Chips on collar	N	Clearly visible, no risk of leakage 25%-50% of surface affected in one location of the vial, non-accumulative	1.0
05.11.0	Folds or notches in shoulder, neck, collar	C	Sealing surface > 50% affected in one position	None allowed *
05.11.0	Folds or notches in shoulder, neck, collar	M	25% - 50% of sealing surface affected in one position	0.4
05.12.0	Folds or notches in shoulder, neck, collar	N	Sealing not affected, function not impaired, 1 notch > 0.5 mm width on collar side, several notches length > 2/3 of collar height and > 2/3 of circumference	4.0
05.14.0	Airlines	N	Closed airlines width > 0.1 mm and length > 4.0 mm	0.4
05.14.0	Airlines	M	Open airline at inside, width > 0.1 mm and length > 4.0 mm	0.04
05.15.0	Air bubbles	M	Diameter > 1 mm	0.1
05.15.0	Air bubbles	N	Diameter 0.5 to 1 mm	1.0
05.16.1 05.16.2	Inclusions (knots & stones)	M	Size > 1 mm	0.1
05.16.1 05.16.2	Inclusions (knots & stones)	N	Size 0.3 to 1 mm	1.0
05.19.0	Cooling stress out of tolerance	M (A)	Testing procedure according to TP no. RG 19.05/-	0.4
05.18.0	Glass threads inside	M	Length > 2mm and width > 0.3 mm	0.4
05.13.0	Scratches	N	- 1 scratch width > 0.2 mm and length > 20 mm - 2 or more scratches width > 0.2 mm and sum of length > 40 mm - 1 radial scratch width > 0.2mm and > 1/2 of circumference	4.0
05.50.0	Tools marks (scars) in shoulder or neck	N	Marks and scars which are clearly visible by naked eye	2.5
05.51.0	Pressure marks on neck	M	Ring shape, near neck and shoulder, visible by naked eye	0.25
05.51.0	Pressure marks on neck	N	Spiral shape or vertical, length of > 1/2 neck height and > 1/2 circumference	1.0
05.50.0	Tool marks on bottom	N	Grooves and notches > 3 mm or rough surface or rings with a width > 2 mm or tool marks clearly visible from top through opening. Function impaired.	1.0
06.07.0	Wavy bottom	M (A)	High and low areas where the side wall meets the bottom resulting in an incomplete footprint and not usable	0.1

## Chemical/Biological/Particulate Specifications

Item	Test	Defect Class if failure	Specification Limit	AQL
A	Endotoxin	C	< 0.25 EU / ml	None allowed
B	Residual ETO	C	< 1 µg / ml	None allowed
C	Residual ECH	C	< 50 µg / ml	None allowed
D	Subvisible particles Particle count ≥ 10 µm	M	< 600 Particles / container (10% USP 788)	0.1
E	Subvisible particles Particle count ≥ 25 µm	M	< 60 Particles / container (10% USP 788)	0.1

\*50 ppm allowed in lot.  
\*\*in the delivery

C = FBL\* Defect Class 1= Critical Defect. Critical defects are those whose presence can have critical consequences.  
M = FBL Defect Class 2 = Major Defect. Major defects are defects whose presence can lead to considerable impairments.  
M (A) = Usability of packaging material markedly impaired.  
M (B) = Usability of packaging material moderately impaired.  
N = FBL defect Class 3 = Minor Defect. Minor defects are defects whose presence does not have essential consequences, e.g. they represent a reduction in general quality.  
\* FBL: Defect Evaluation List 2009 (DEL).

### Notes:

- Schott's defect manual lists a number of additional, potential cosmetic glass imperfections, these are classified as Acceptable Cosmetic Imperfections (ACI), unless otherwise stated.
- Cosmetic defects are verified under Standard inspection conditions: as defined in USP <790>
- Dimensions are non API, unless otherwise specified
- All defects are non-cumulative.

## 6. History

Version	Date of change	Description of change
00	09-03-2019	Development article initial version
01	04-12-2021	Article release for human use via CR-00176

## 7. Drawings

Annex 1 / 10000003405 / 6R NBB.....	9
Annex 2 / 2233515-02 / 6R Tray Base .....	10
Annex 3 / 2233514-02 / 6R/8R Tray Insert.....	11
Annex 4 / 1293572-03 / adaptiQ® packaging 6x5 .....	12



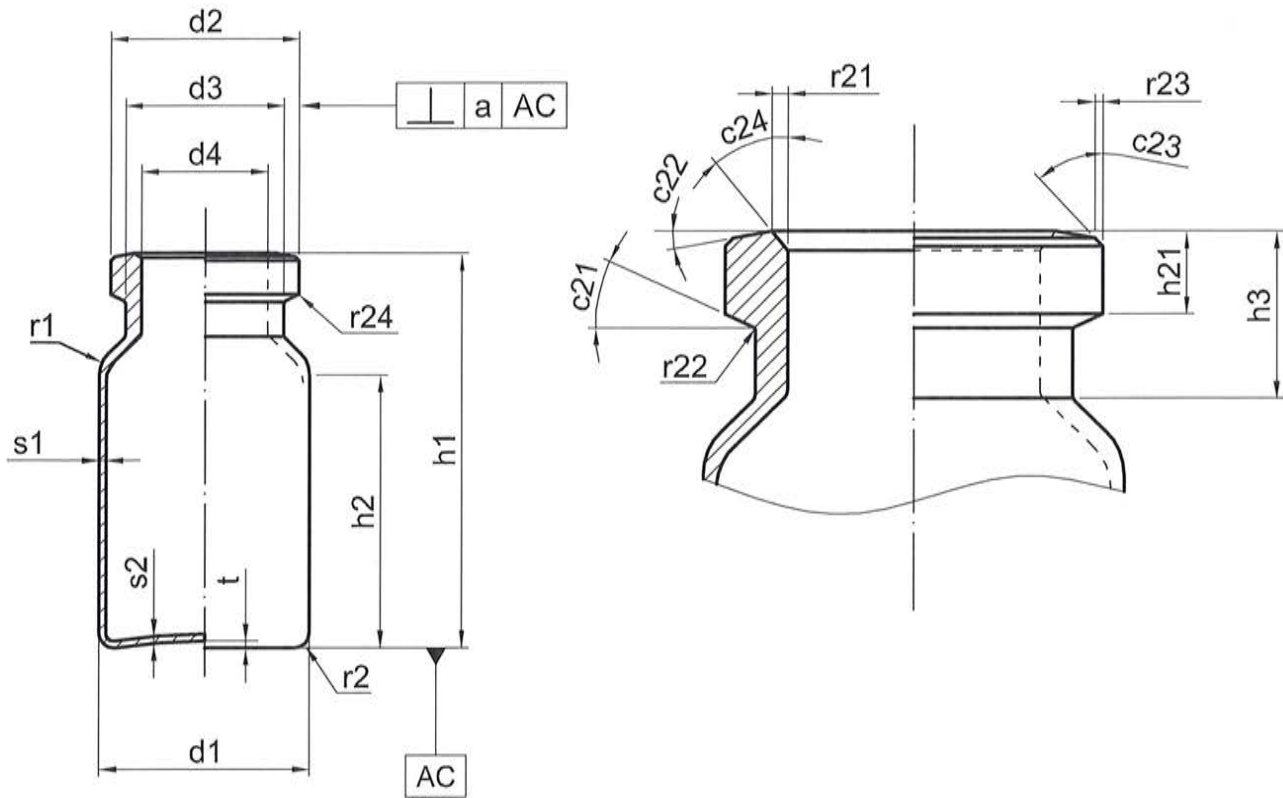

d1	22,0	+ 0,2	-0,2	c21°	10,0	+ 5,0	-5,0	r21	0,5	ca.	
d2	20,0	+ 0,2	-0,3	c22°	3,0	+ 2,0	-2,0	r22	0,5	ca.	
d3	16,5	max.		c23°	45,0	ca.		r23	0,5	ca.	
d4	12,6	+ 0,2	-0,2	c24°	45,0	ca.		r24	0,5	ca.	
h1	40,0	+ 0,5	-0,5	s1	1,0	+ 0,04	-0,04	t	0,7	max.	
h2	26,0	min.		s2	0,7	min.		a	1,2		
h3	8,5	+ 0,5	-0,5	r1	3,5	ca.					
h21	3,6	+ 0,2	-0,2	r2	2,0	ca.					

Modification	Previously	New	Date	Vers.

Description: <b>Vial ISO 8362-1 6R-1</b>		Creator: <b>Bálint Szabados</b>		Product drawing <b>SCHOTT</b> <b>forma vitrum</b>
Drawing Number: <b>10000003405</b>		Approved: <b>Lajos Pungor</b>		
		Status: <b>RD</b>	<b>15.01.2010</b>	
Drawing ID: 10000003405-000/00				NOTE: Linear dimensions are in millimeter



X 2:1

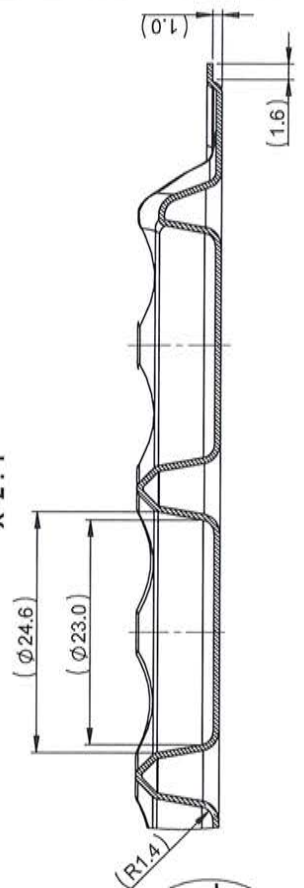

A-A

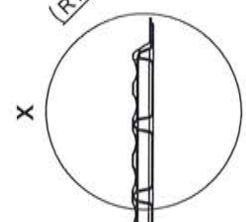

X

337.0 <sup>+1.0</sup> -2.0

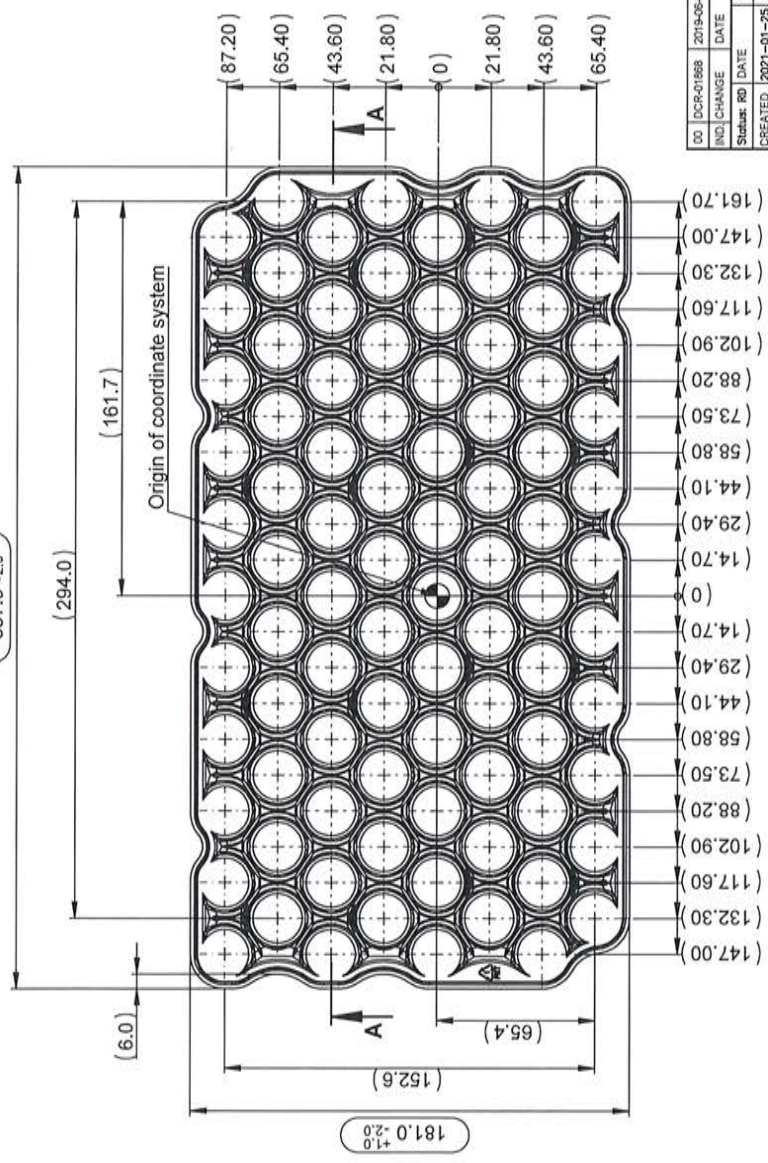

181.0 <sup>+1.0</sup> -2.0

(152.6)

(65.4)

(6.0)

(294.0)

(161.7)

Origin of coordinate system

- (147.00)
- (132.30)
- (117.60)
- (102.90)
- (88.20)
- (73.50)
- (58.80)
- (44.10)
- (29.40)
- (14.70)
- (0)
- (14.70)
- (29.40)
- (44.10)
- (58.80)
- (73.50)
- (88.20)
- (102.90)
- (117.60)
- (132.30)
- (147.00)

- (87.20)
- (65.40)
- (43.60)
- (21.80)
- (0)
- (21.80)
- (43.60)
- (65.40)

1:5

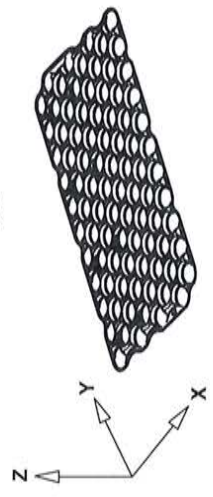

8x11 = 88 cavities

IND. CHANGE	DATE	IND. CHANGE	DATE	IND. CHANGE	DATE	IND. CHANGE	DATE	IND. CHANGE	DATE
00	DCR-01668	2019-06-26	01	DCR-01957	2019-10-04	02	YPC-01179	2021-01-25	
CREATED: 2021-01-25 Martin Müller APPROVED: 2021-01-25 Francisco Elio Craldo RELEASED: 2021-01-25 Marco Müller									
STATUS: RD NAME: Martin Müller GENERAL TOLERANCE: DIN ISO 2768-m SCALE: 1:2 WEIGHT: 69.88 DOCUMENT TYPE: CUSTOMER DRAWING									

DESCRIPTION  
**SCHOTT** adaptiQ® Tray Base 6R/8R  
 PG TYI PET 337x181x9.0 BE 88 23.0 6R-8R

DRAWING NUMBER: 2233514  
 INDEX: 02  
 MATERIAL: PETG  
 PAGE: / 1

CONFIDENTIAL

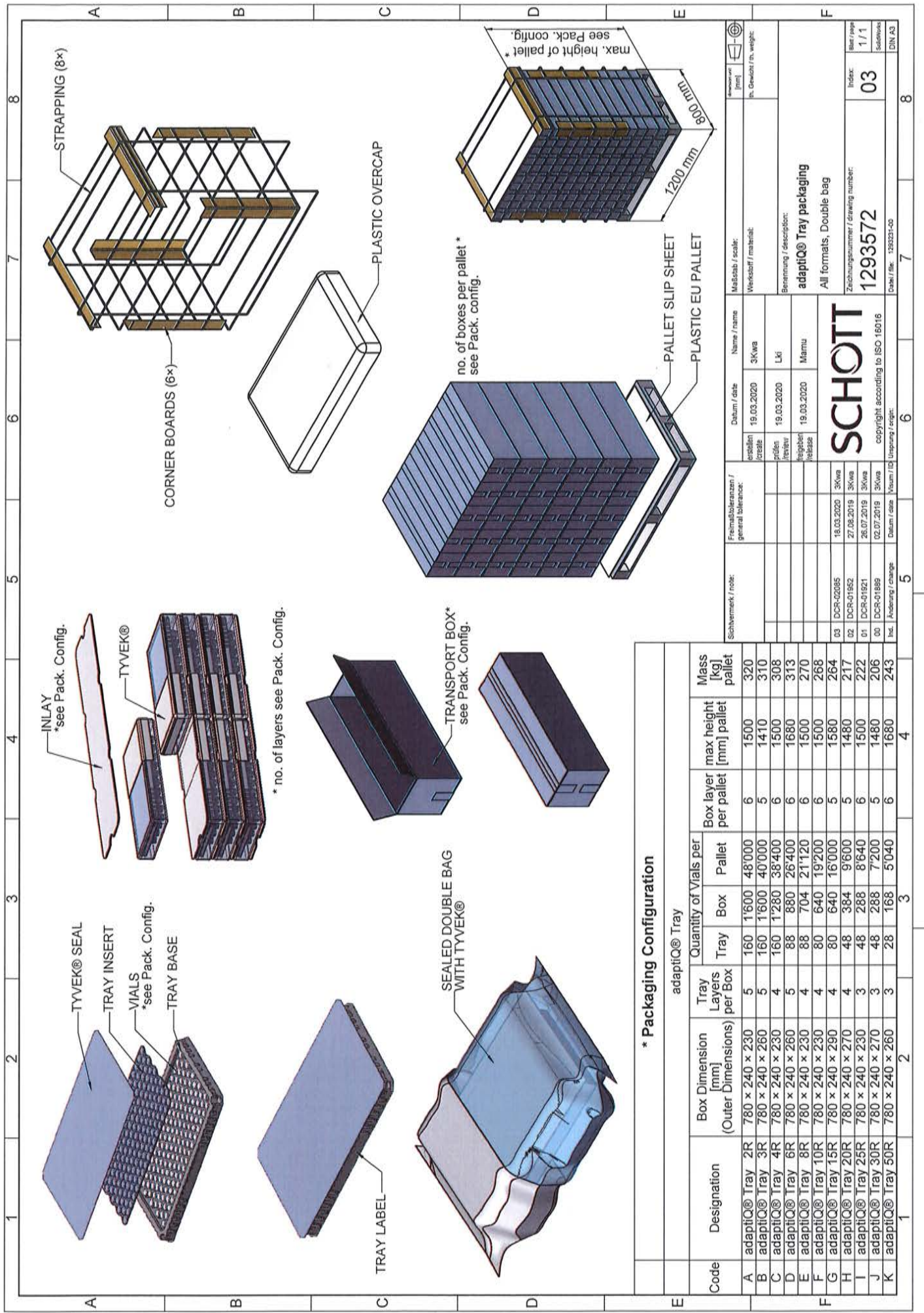

**\* Packaging Configuration**  
adaptiQ® Tray

Code	Designation	Box Dimension [mm] (Outer Dimensions)	Quantity of Vials per		Box layer max height [mm] pallet	Mass [kg] pallet
			Tray Layers per Box	Pallet		
A	adaptiQ® Tray 2R	780 x 240 x 230	5	1600	1500	320
B	adaptiQ® Tray 3R	780 x 240 x 260	5	1600	1410	310
C	adaptiQ® Tray 4R	780 x 240 x 230	4	1280	1500	308
D	adaptiQ® Tray 6R	780 x 240 x 260	5	880	1680	313
E	adaptiQ® Tray 8R	780 x 240 x 230	4	88	1500	270
F	adaptiQ® Tray 10R	780 x 240 x 230	4	80	1500	268
G	adaptiQ® Tray 15R	780 x 240 x 290	4	80	1580	264
H	adaptiQ® Tray 20R	780 x 240 x 270	4	48	1480	217
I	adaptiQ® Tray 25R	780 x 240 x 230	3	48	1500	222
J	adaptiQ® Tray 30R	780 x 240 x 270	3	48	1480	206
K	adaptiQ® Tray 50R	780 x 240 x 260	3	28	1680	243

Freimaßtoleranzen / general tolerances:	Sicherheitsmerkmal / note:	Stollen / create:	Datum / date:	Name / name:	Maßstab / scale:	Werkstoff / material:
		größen / review:	19.03.2020	3Kwa		
		Änderungen / change:	19.03.2020	Lki		
		Datum / date:	19.03.2020	Mamu		
<b>SCHOTT</b>						
Copyright according to ISO 15016						
1293572						
adaptiQ® Tray packaging						
All formats, Double bag						
Zachungsnummer / drawing number:						
1293572						
Index:						
03						
Blatt / page:						
1 / 1						
Datum / date:						
19.03.2020						
Date / file:						
1293291-00						
DIN A3						